

Container Gardens

All designs utilize galvanized metal water trough containers 4' long x 2' wide x 2' tall. All are designs for full sun locations, meaning they should receive at least six hours of sun per day to bloom or fruit. Water troughs are available at local farm and ranch supply stores for about \$70 each, but if you plan to do several, you should call around to check availability. The cattle guard for the trellis design is available from McCoy's Building Supply.

Container Preparation

- Using a ½" metal drill bit, drill 12 to 15 holes in the bottom of the trough for drainage. Scatter the holes evenly over the surface, so every area will drain well.
- If you wish to paint the container, use exterior latex paint. Paint only the outside of the trough.
- Place the container in its permanent location before filling. It will be heavy.
- First, fill the bottom 6" with empty aluminum cans. (Turn them upside down to keep soil out.) This level may be rocks or styrofoam peanuts if cans are not available.
- Next, fill the container to within 2" of the top with a mixture of equal parts potting soil and cotton burr compost.

Planting

- Apply pelletized nitrogen fertilizer according to package directions when planting each individual plant.
- Plant each plant at the same level it is in its purchased plant, except tomatoes. Remove the bottom leaves and plant a few inches of the stem of the tomato plants.
- Water in well and keep plants moist until they are well established (a few weeks).

Mulching

Mulch will keep the roots of your plants moist and help regulate their temperature. Use a thick layer of mulch—all the way to the top of the container. Any hardwood mulch is fine. Free mulch is available at The Time Machine in Odessa. If you choose to purchase mulch (it will be more attractive), we recommend shredded cypress.

Caring for Your Container Gardens

- **Water:** Plants in containers dry out more quickly than those in the ground. Check the moisture by inserting your finger one inch into the soil. If it feels cool, it is moist. If it is air temperature, water. This is trial and error. Just keep checking, and you will figure out how often to water. It is always better to water heavily and less frequently to be sure the roots grow deep.
- **Perennials:** When perennials (the plants that come back for two years or more) die back in winter, they need to be cut down. February is the best time to do this. Cut them back nearly to the ground. For plants in public areas, it is okay to cut back sooner for appearance sake if you wish.
- **Annuals:** When the annual plants (the ones that don't come back) die, just pull them up and discard them. Don't leave the dead ones in the container. They attract bugs and contribute to disease.
- **Flowers:** Most flowering plants, annual and perennial, have flowering cycles. To encourage them to bloom more and more often, remove the dead flowers regularly. This is a quick, easy way to get more flowers, and is something your residents will be able to do easily, even if they are not up to the work of planting or regular care.

KNOCKOUT ROSE GARDEN

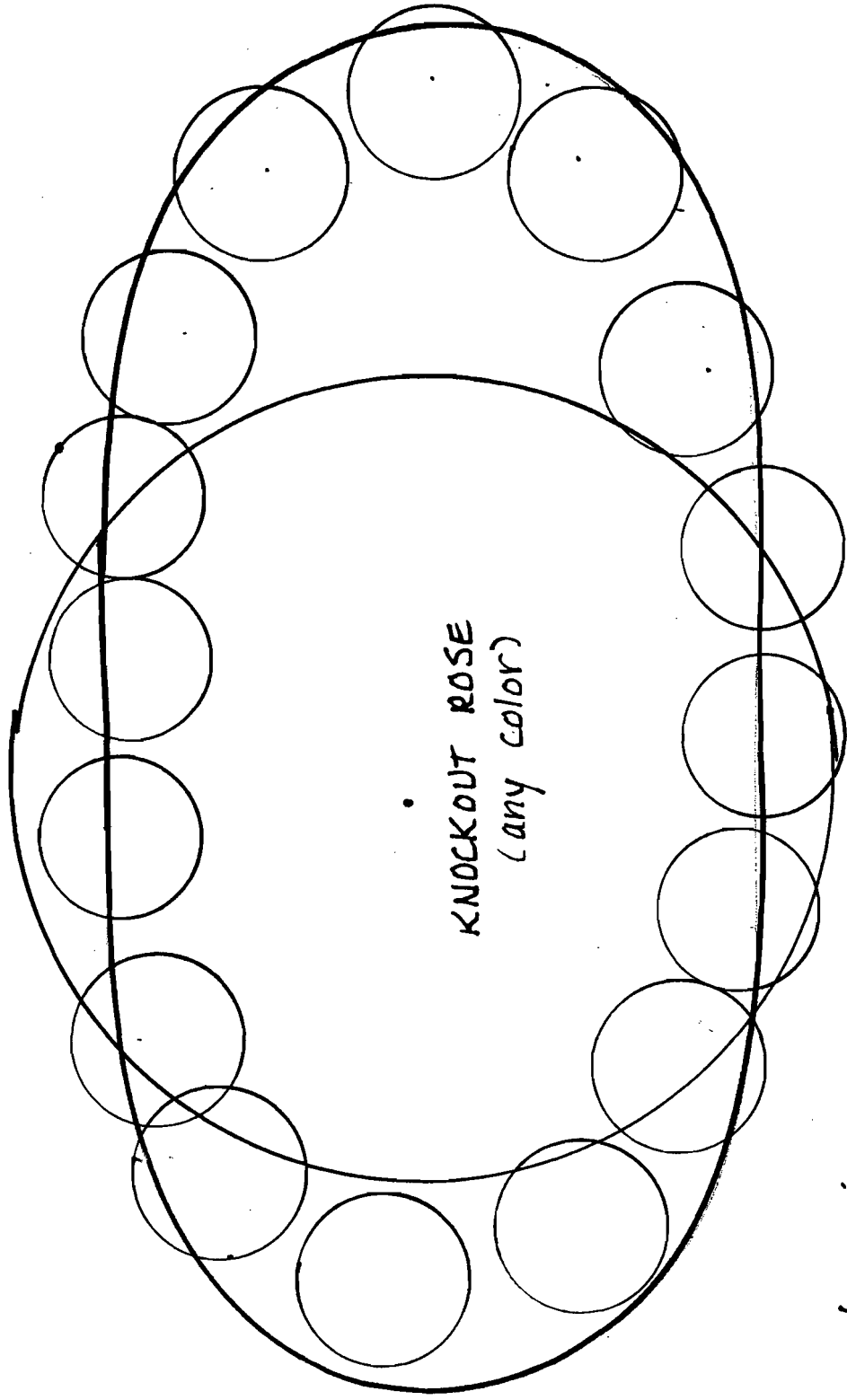

NOTE: Surround 4 single
rose with sweet alyssum (15-20).

FRAGRANT HERB GARDEN

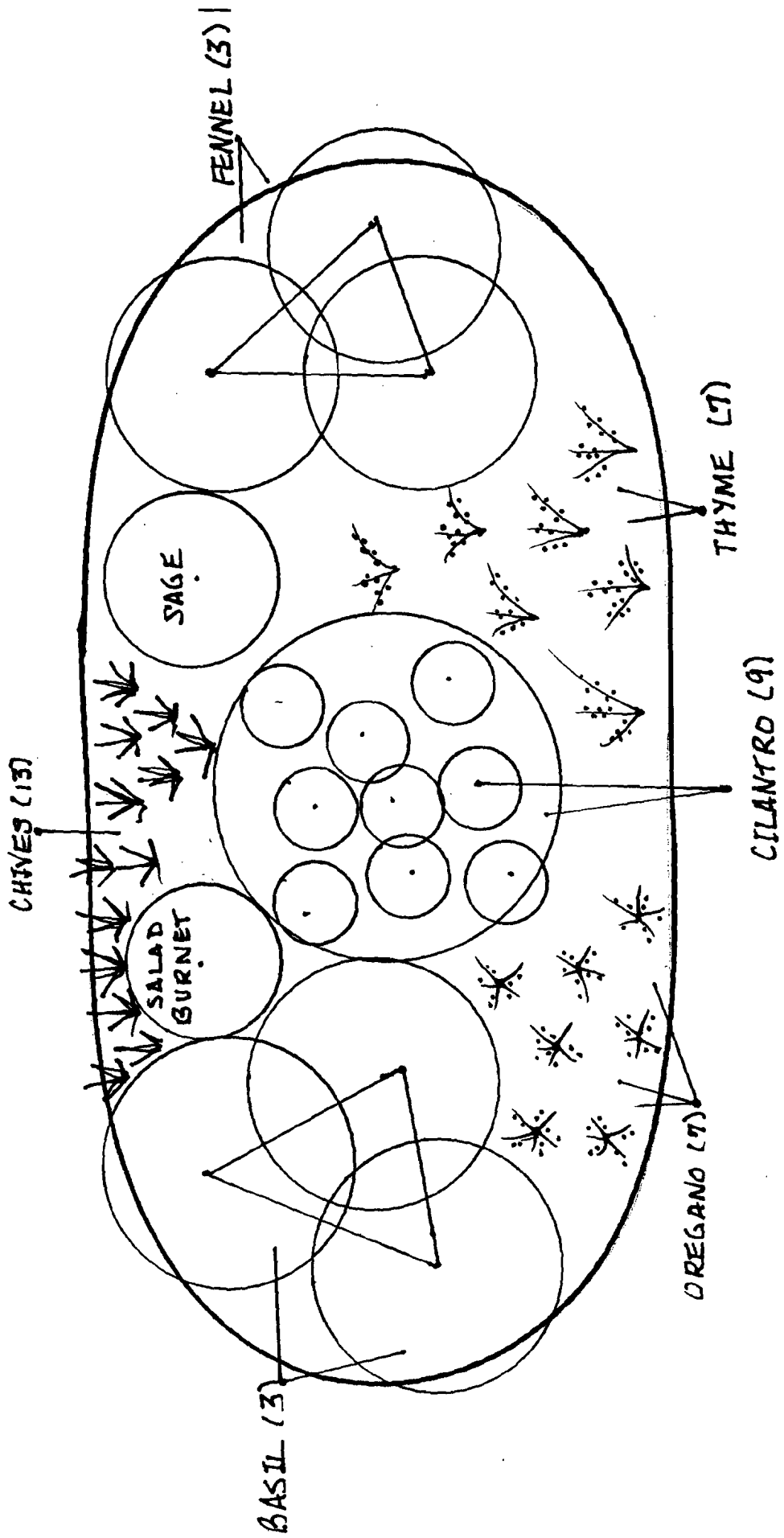

Winter Flower Garden

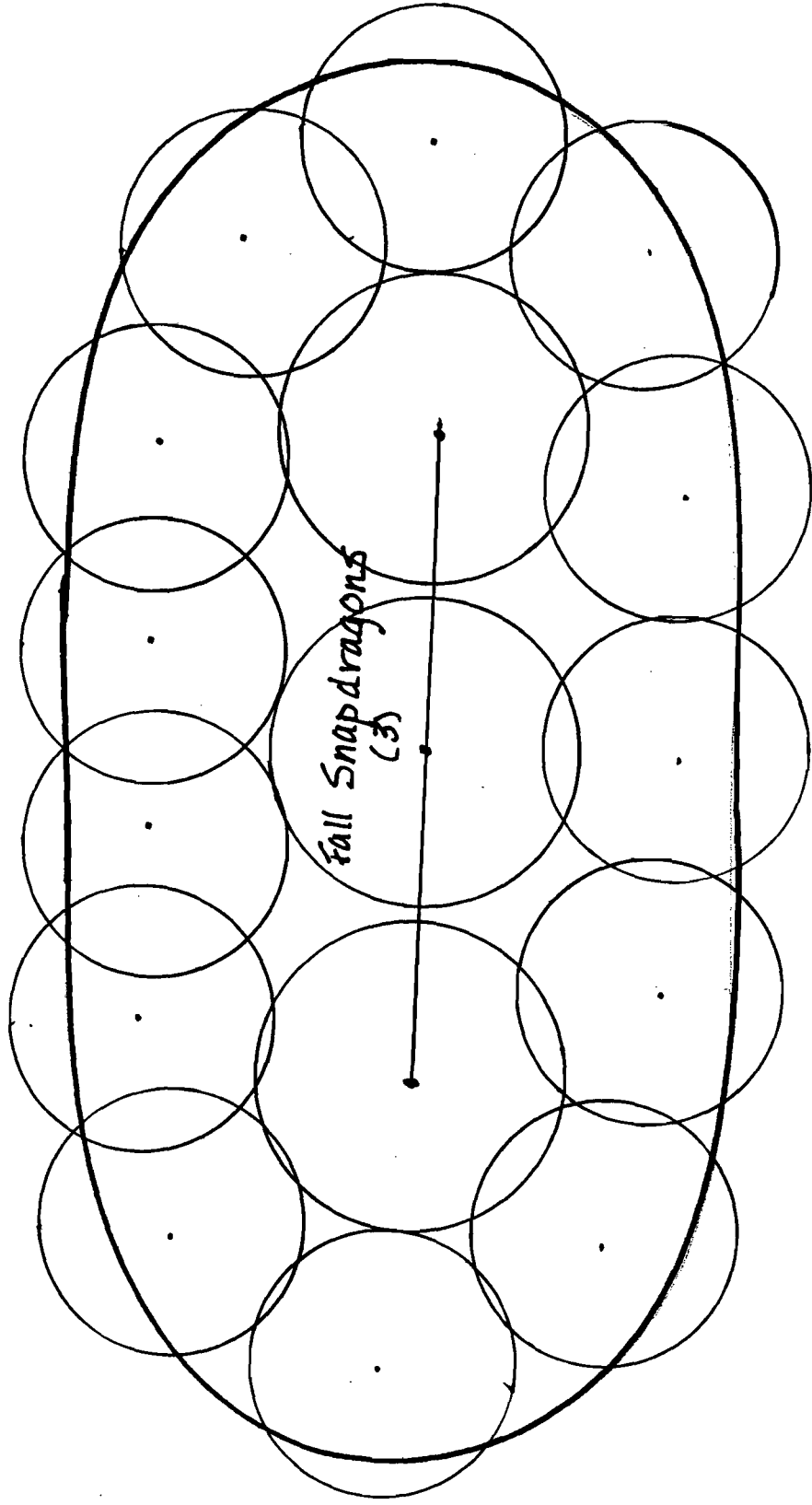

Outer Ring: Mix Pansies, Johnny Jump-ups
and Calendula.

Classic Herb Garden

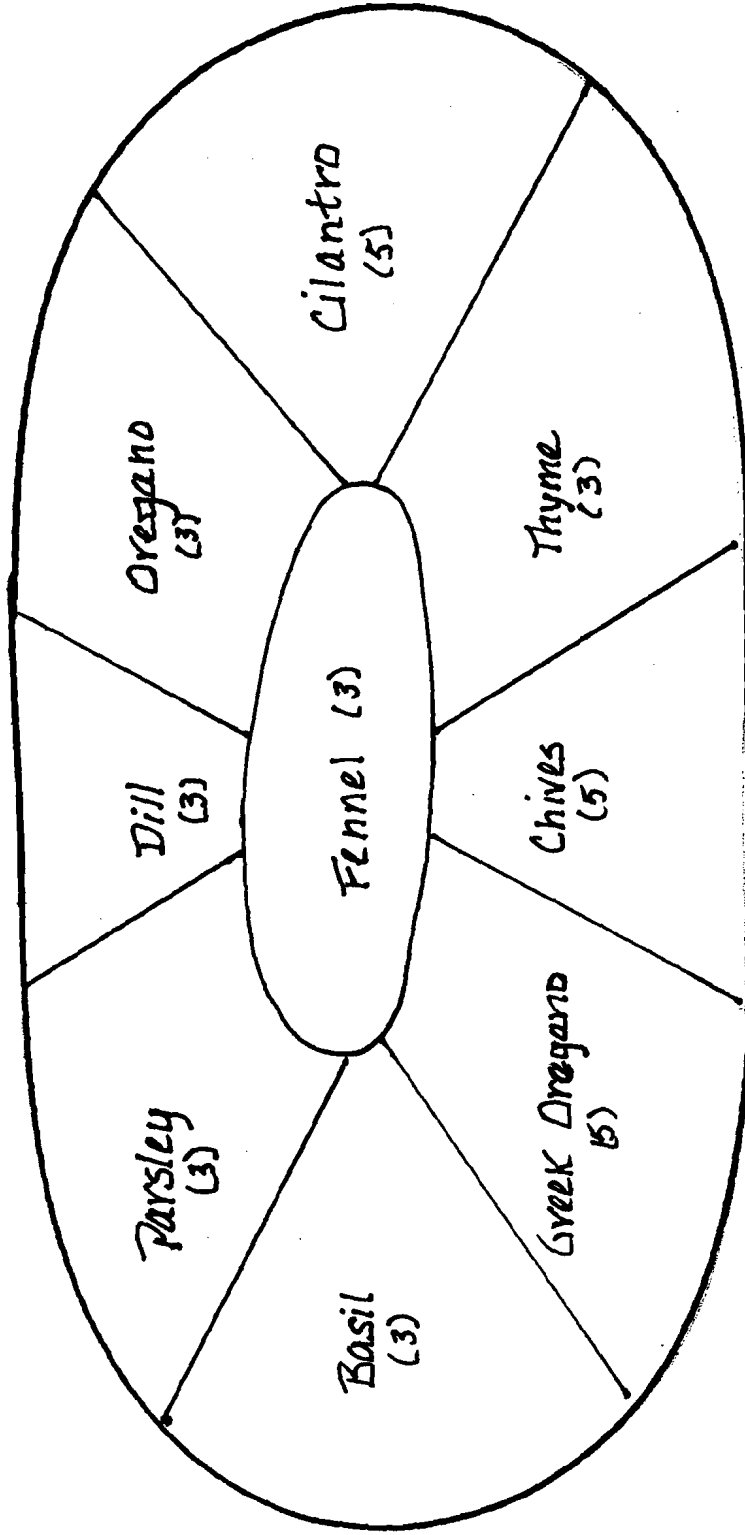

Perennial Garden with Fall Color

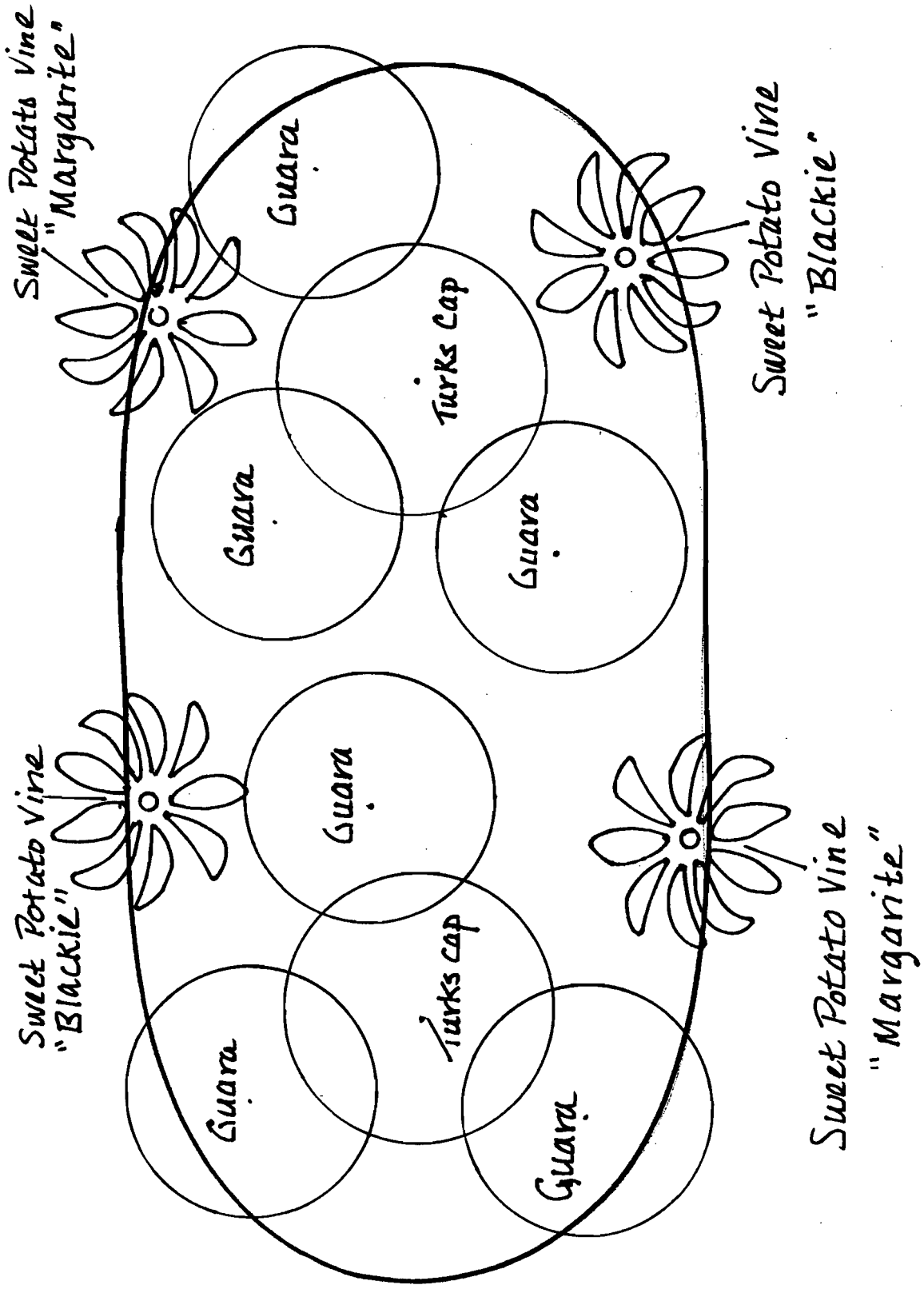

ARTICHOKE GARDEN

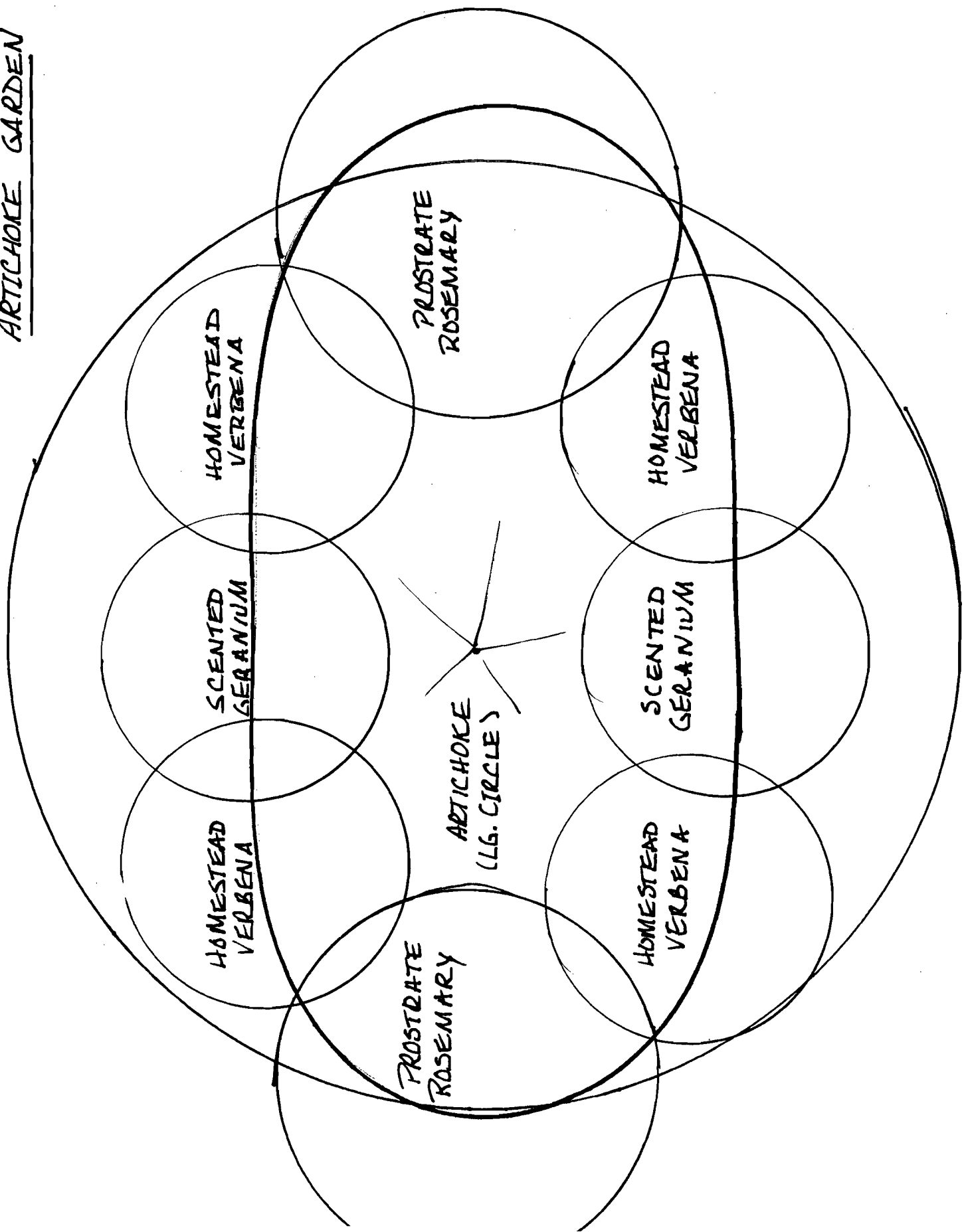

WINTER VEGETABLE GARDEN

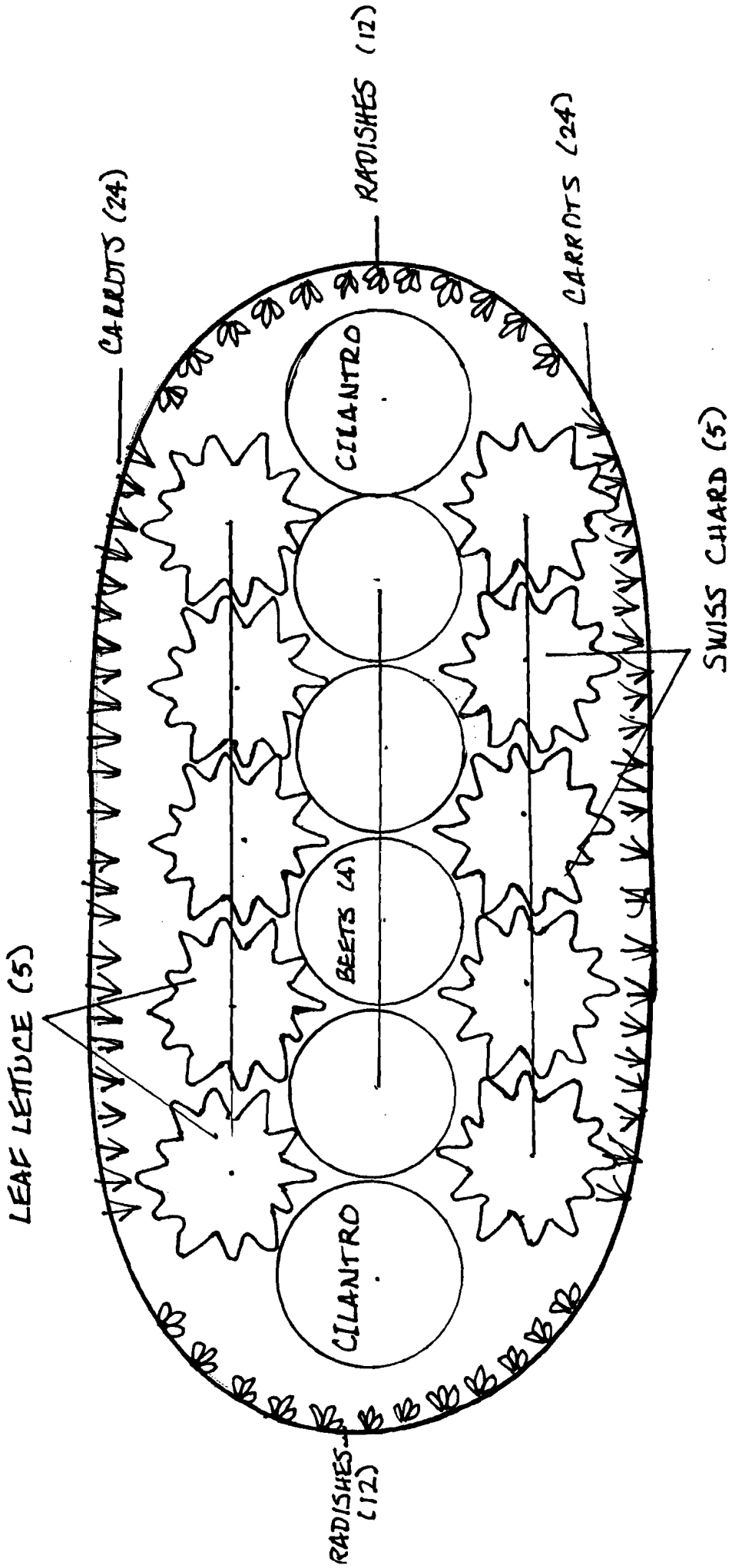

PERENNIAL GARDEN
(SPRING & SUMMER COLOR)

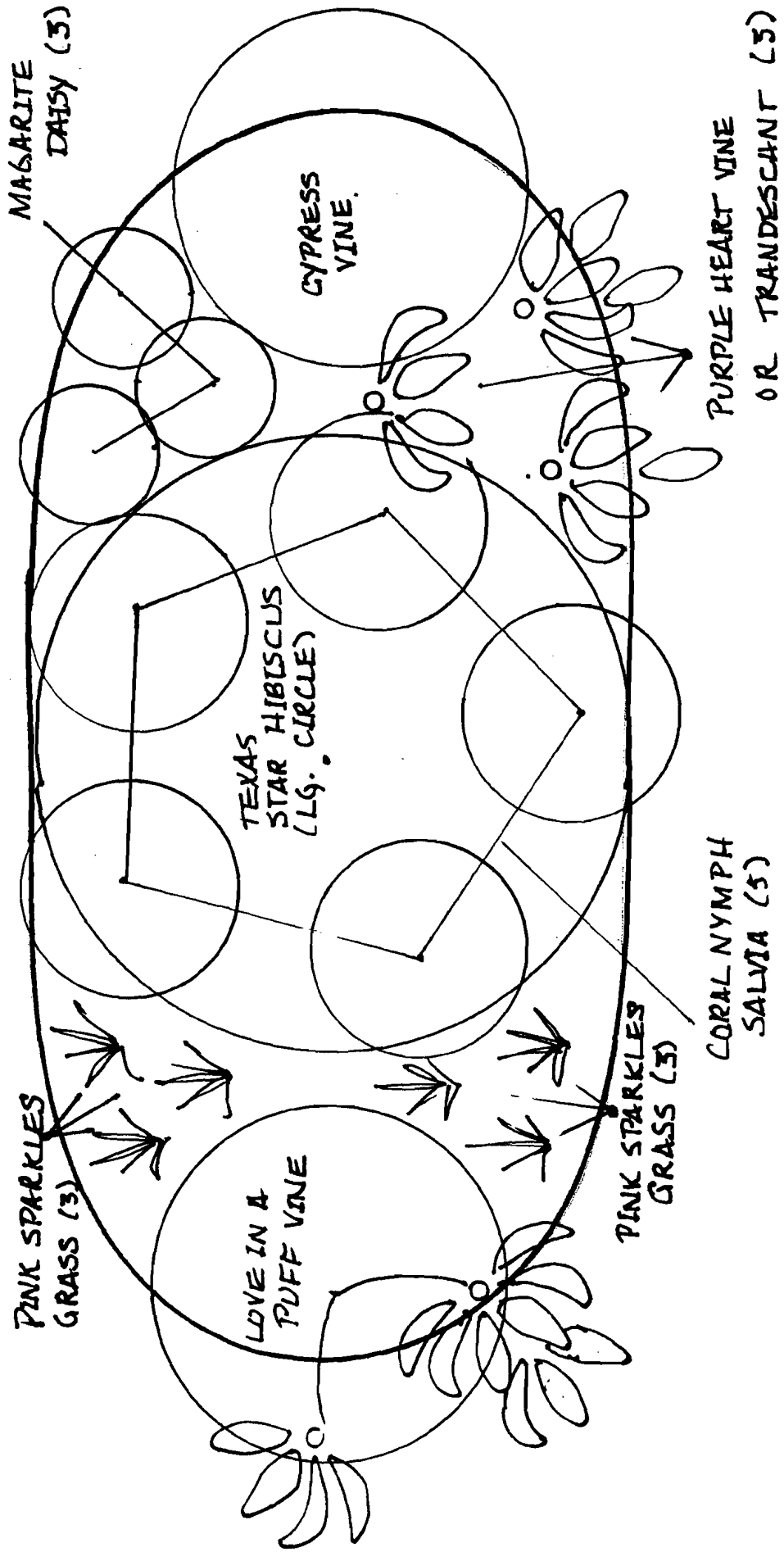

SUMMER SALAD GARDEN

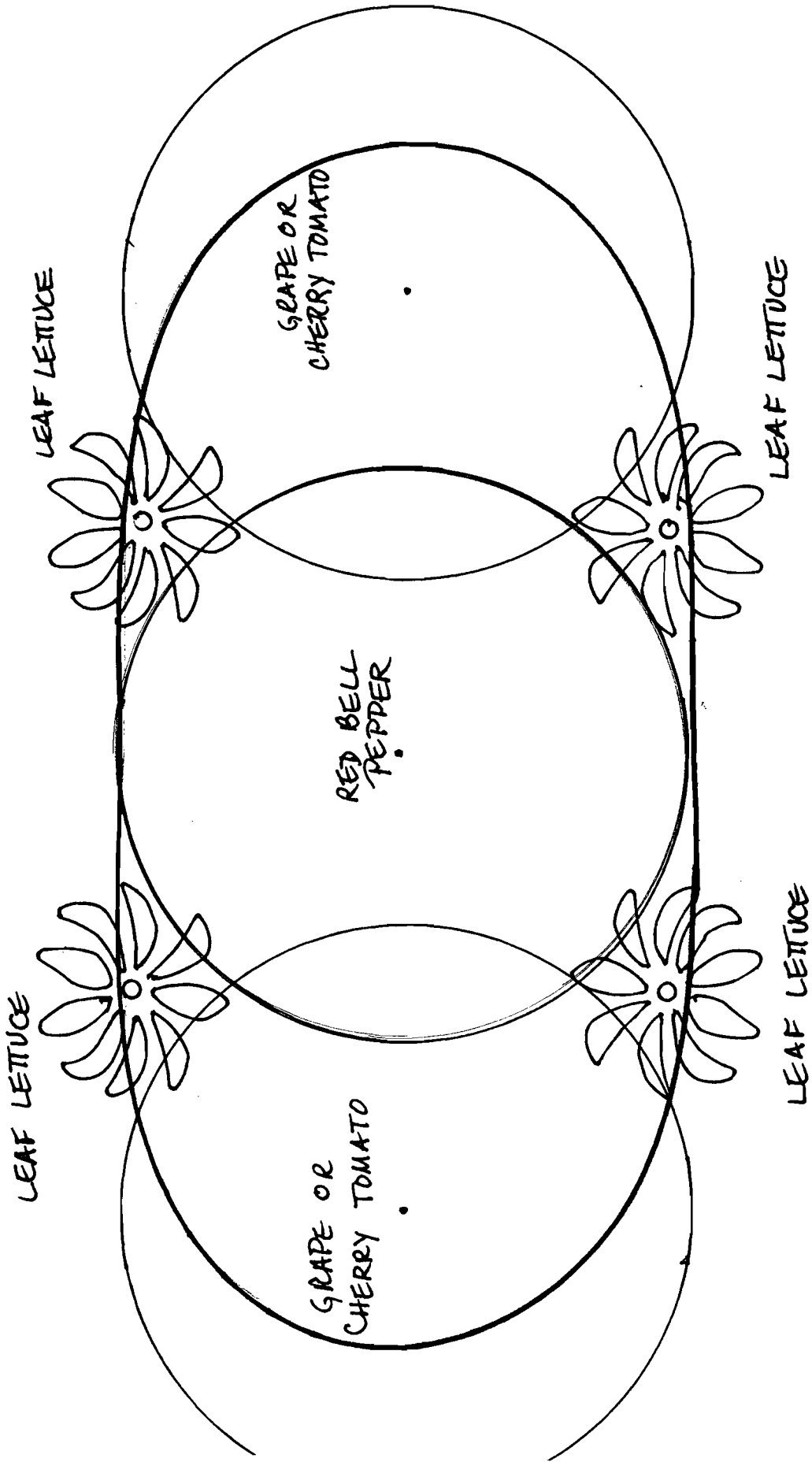

HERBS & EDIBLE FLOWERS

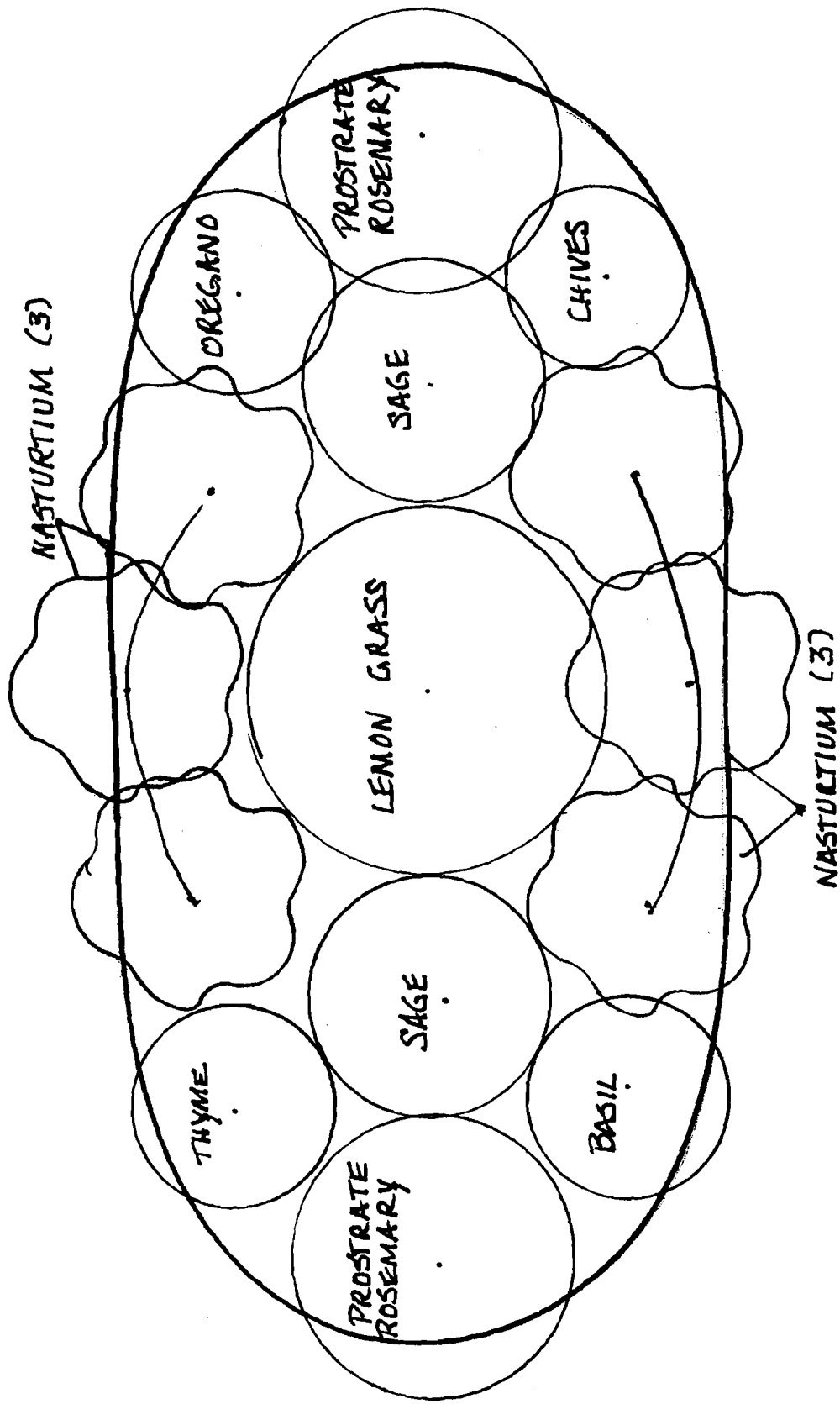

Summer-Into-Fall Color Garden

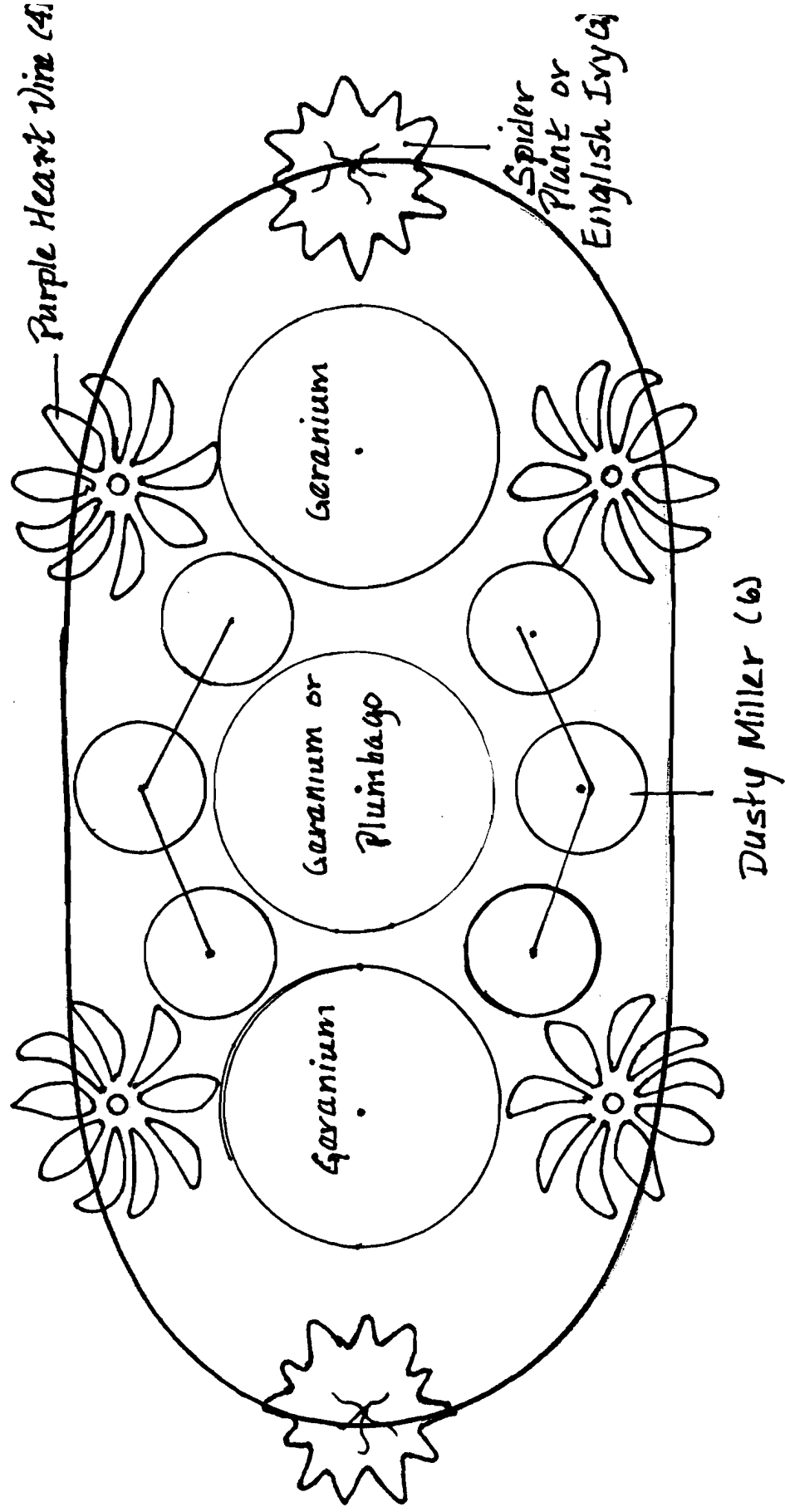

Note: When geraniums fade in fall, replace them with pumpkins for seasonal interest.

Trellis Garden

- Dig holes in ground 1'2-2'.
- Fill with quick-dry cement.
- Sink 6' long 4"x4" poles into cement. Let dry.
- Attach 4'2" x 16' cattle quare to poles forming arch.

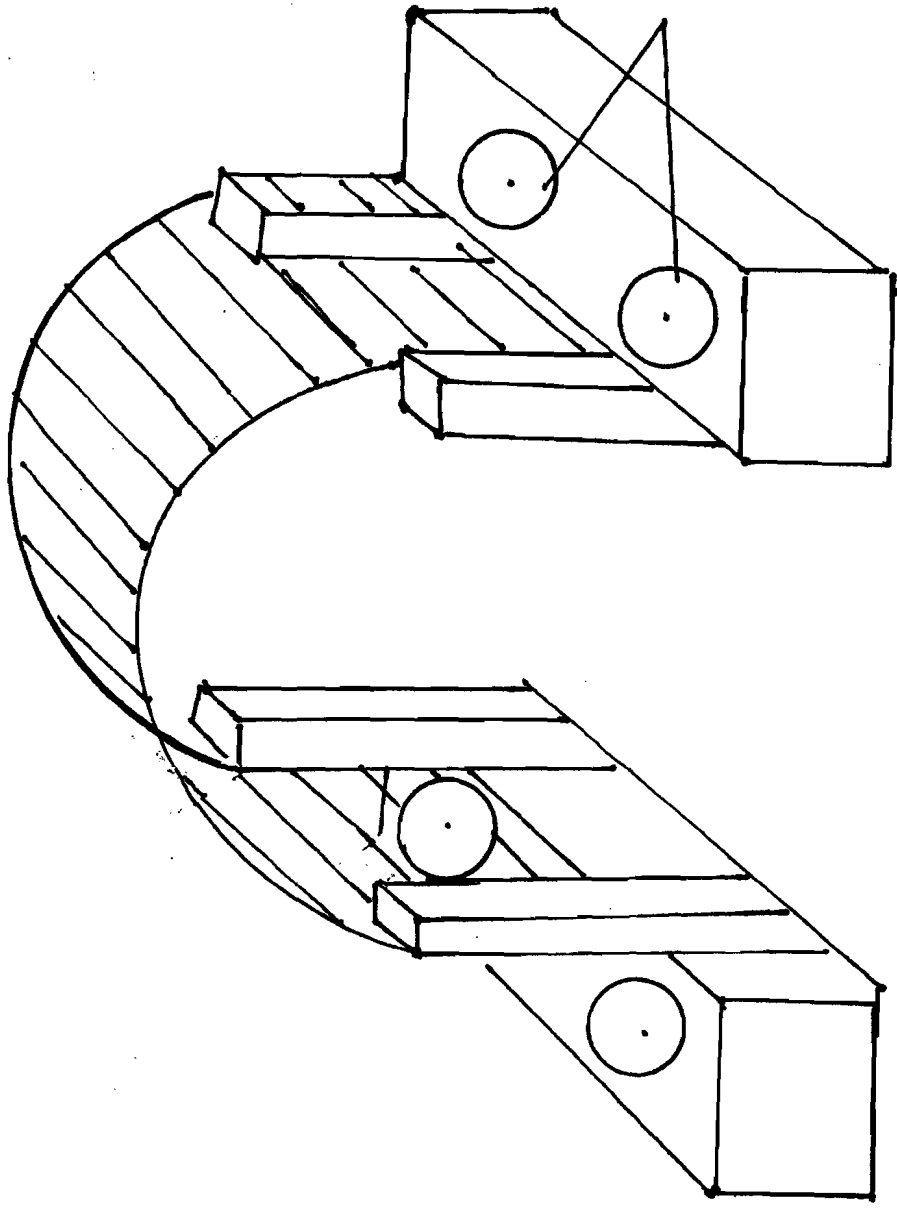

Vining Plants (4)

NOTE:

Space 4' apart to accommodate wheelchair and tall enough to walk under.

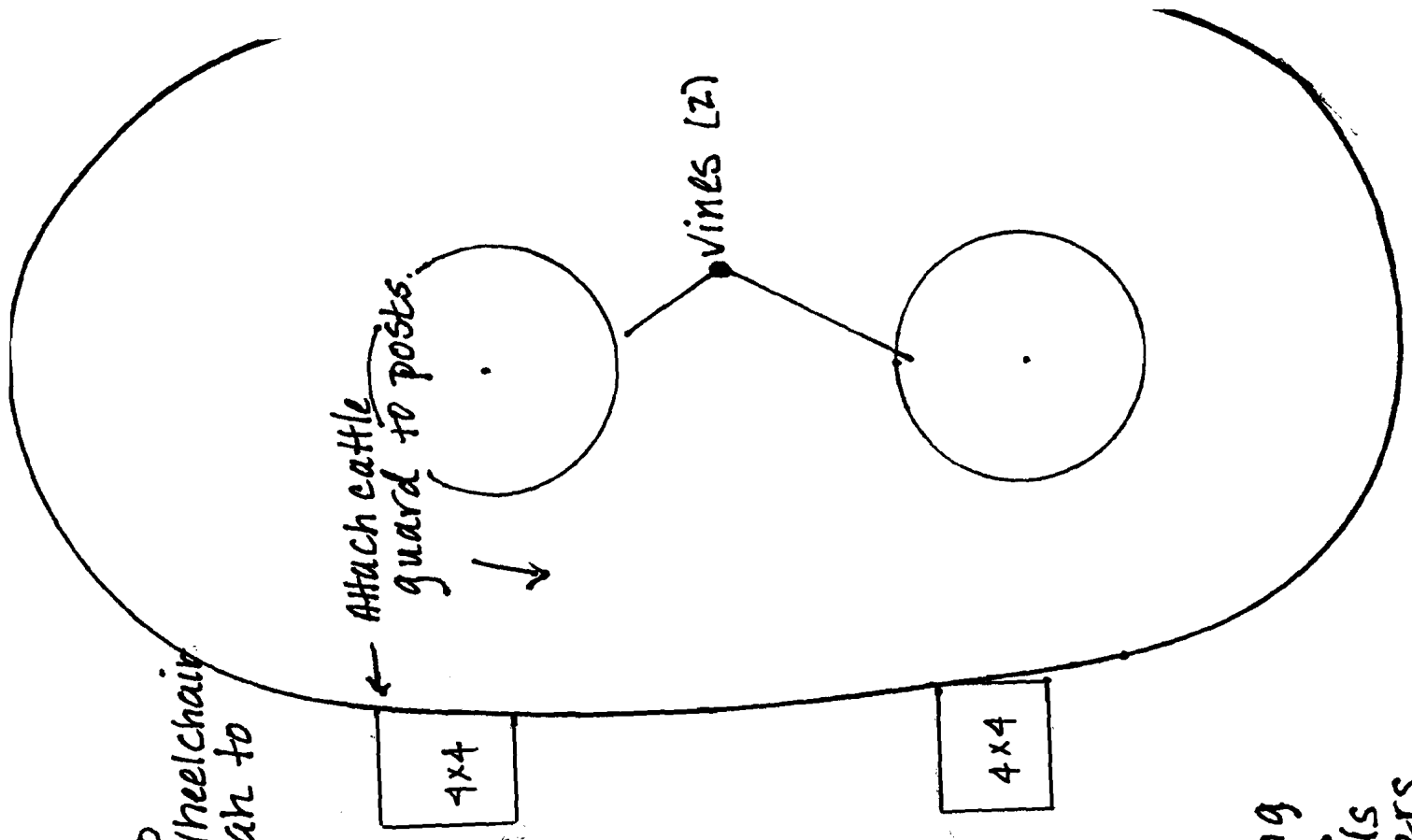
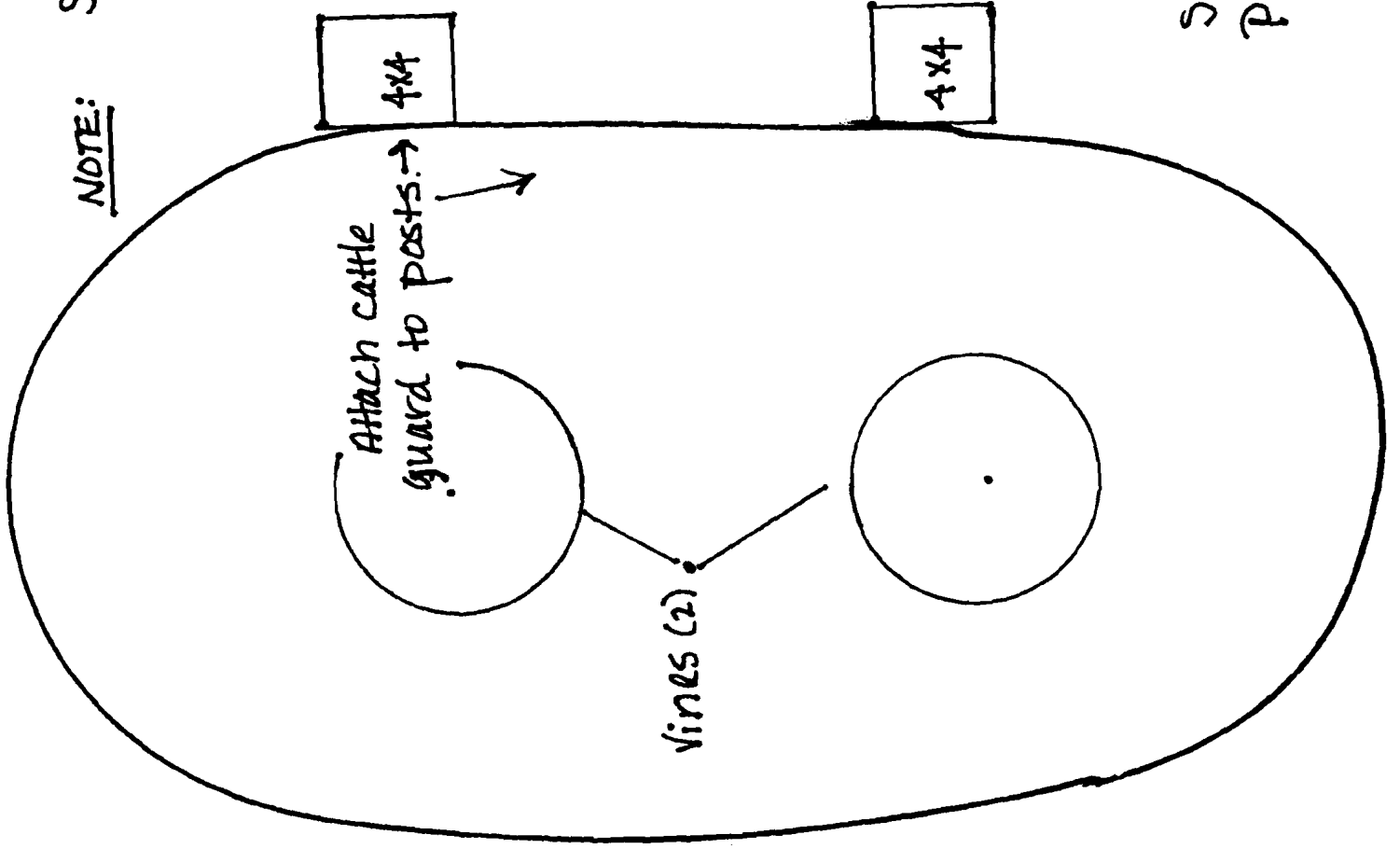

- Suggested Vining Plants:
- Beans
 - Gourds
 - Flowers